

EVALUATION OF TITANIUM ULTRALIGHT MANUAL WHEELCHAIRS USING
ANSI/RESNA STANDARDS

By

Hsin-yi Liu

Bachelor of Science in Physical Therapy, National Taiwan University, 2001

Submitted to the Graduate Faculty of
School of Rehabilitation Science and Technology in partial fulfillment
of the requirements for the degree of
Master of Science

University of Pittsburgh

2008

UNIVERSITY OF PITTSBURGH
SCHOOL OF REHABILITATION SCIENCE AND TECHNOLOGY

This thesis was presented

By

Hsin-yi Liu

It was defended on

March 20, 2008

And approved by

Rory A. Cooper, PhD, Department of Rehabilitation Science and Technology

Jon Pearlman, PhD, Department of Rehabilitation Science and Technology

Rosemarie Cooper, MPT, Department of Rehabilitation Science and Technology

EVALUATION OF TITANIUM ULTRALIGHT MANUAL WHEELCHAIRS USING
ANSI/RESNA STANDARDS

Hsin-yi Liu, BS

University of Pittsburgh, 2008

A series of commercially available titanium ultralight wheelchairs were tested using ANSI/RESNA testing procedures, and their durability was compared with previously tested aluminum ultralight wheelchairs and light-weight wheelchairs. Three of each of the following titanium wheelchairs were tested: Invacare-TopEnd, Invacare-A4, Quickie-Ti, and TiLite-ZRA. The Quickie-Ti wheelchairs had the most forward and rearward center of gravity adjustability. All of the titanium wheelchairs passed the forward braking effectiveness test, but two chairs of each model tipped backward before the platform inclining to 7 degree in the rearward braking effectiveness test. All titanium wheelchairs passed the impact strength tests, but two failed in the static strength tests: two Invacare-TopEnd wheelchairs and one Invacare-A4 wheelchair failed due to deformation of the armrest mounting plates, and the handgrips of the TiLite-ZRA wheelchairs slid off the push handles. Two Invacare-A4 and one Invacare-TopEnd successfully completed the double drum and curb drop tests, but the remaining 9 wheelchairs failed prematurely. No significant differences were found in the number of the equivalent cycles or the value among the four models. The titanium ultralight wheelchairs had less equivalent cycles and value than the aluminum ultralight wheelchairs that were tested in a previous study. The failure modes in the static strength tests and the fatigue tests were consistent within the model, and

revealed important design issues for each model. Our results suggest that manufacturers need to perform more careful analyses before commercializing new products.

TABLE OF CONTENTS

PREFACE	xi
1.0 INTRODUCTION	1
2.0 METHODS	4
2.1 STUDY WHEELCHAIRS	4
2.2 STANDARD TESTING PROCEDURE	6
2.2.1 General	6
2.2.2 Static Stability	6
2.2.3 Braking Effectiveness	8
2.2.4 Static, Impact and Fatigue Strength Test (Durability Testing)	9
2.3 COST EFFECTIVENESS	12
2.4 DATA ANALYSIS	12
3.0 RESULTS	13
3.1 STATIC STABILITY	14
3.2 BRAKING EFFECTIVENESS	17
3.3 IMPACT AND STATIC STRENGTH TESTS	18
3.4 FATIGUE STRENGTH TESTS (DURABILITY TESTING), EQUIVALENT CYCLES, AND COST EFFECTIVENESS	19

4.0 DISCUSSION.....	24
4.1 GENERAL.....	24
4.2 STATIC STABILITY.....	25
4.3 BRAKING EFFECTIVENESS	26
4.4 IMPACT AND STATIC STRENGTH TESTS	26
4.5 FATIGUESTRENGTH TESTS (DURABILITY TESTS).....	27
4.6 FAILURE MODES.....	31
4.6.1 Invacare-TopEnd.....	31
4.6.2 Invacare-A4.....	35
4.6.3 Quickie-Ti and TiLite-ZRA.....	40
4.7 LIMITATIONS.....	43
4.8 FUTURE WORK.....	45
4.8.1 Mechanical Engineering of Wheelchair Design	45
4.8.2 Injury and Safety: Biomechanical Engineering and Ergonomics	47
4.8.3 Users’ Satisfaction	48
4.8.4 Development of Guidelines	49
5.0 CONCLUSIONS.....	51
6.0 RECOMMENDATIOONS AND CLINICAL APPLICATIONS	52
6.1 FOR USERS OF RIGID FRAME TITANIUM WHEELCHAIRS.....	52
6.2 FOR CLINICIANS	53
7.0 BIBLIOGRAPHY.....	55

8.0 SUPPLIERS..... 60

LIST OF TABLES

Table 1: Overall Dimension and Feature of Titanium Wheelchairs	13
Table 2: Mean Tilt Angle, Standard Deviation and Range of Tipping Angle in Static Stability Tests	15
Table 3: Sliding Angle in the Braking Effectiveness Tests	18
Table 4: Mean Equivalent Cycles and Mean Value of the Titanium Manual Wheelchairs	20
Table 5: Failure Mode in the Fatigue Tests	23
Table 6: Dimension of the Frame Tubes and Backrest Canes	35

LIST OF FIGURES

Figure 1. Four models of the titanium ultralight wheelchairs in this study.	5
Figure 2. Rearward stability test with the wheelchair in the least stable configuration and rear wheels locked.	8
Figure 3. Setting of the double drum test.	10
Figure 4. Position of the rearwheel axle in the forward stability tests.	16
Figure 5. Two failures in the static strength tests.	19
Figure 6. Equivalent cycles of each wheelchair in the fatigue tests.	21
Figure 7. Numbers of Class I and Class II Failures before the Class III failure occurring during the Fatigue Tests	22
Figure 8. Survival curves for the titanium, ultralight, light-weight, and depot wheelchairs from this and previous comparison studies	28
Figure 9. Value (cycles/\$) of the titanium, ultralight, and light-weight wheelchairs.	29
Figure 10. Backrest cane fracture of an Invacare-TopEnd wheelchair in the DDT	32
Figure 11. The structure nearby the fracture site of the Invacare-TopEnd wheelchairs.	34
Figure 12. Caster stem fracture of an Invacare-A4 wheelchair.	36
Figure 13. Fracture at the middle of the tube in the seat plane of an Invacare-A4.	37
Figure 14. The left frame of the Invacare-A4 showing the locations of screw holes on the tube in the seat plane.	37

Figure 15. Fracture lines (arrows) around the screw holes for the mounting plate between the seat plane and backrest of an Invacare-A4 wheelchair. 38

Figure 16. Footrest of an Invacare-A4 wheelchair. 39

Figure 17. Fracture in the frame tube of the wheelchair having cantilever structure along the seat plane to footrest..... 41

Figure 18. Structure comparison between the cantilever frame and box frame. 42

PREFACE

First and foremost I would like to thank my primary advisor, Dr. Cooper, for providing me the great opportunity to join this project and his guidance during conducting the project and writing the research report. This project is a big step for me to come across from my clinical background as a physical therapist to the entrance into the engineering and academic fields. I would also like to thank Rosi, Jon, Sam, Jeremy, and Mark for your support and help during testing wheelchairs and editing this paper. I would also like to thank all the students and staff at the Human Engineering Research Laboratories (HERL) for helping and supporting me in many ways. Finally, thanks to my family and friends for their love, support, and understanding.

This study was supported by the Department of Veterans Affairs Rehabilitation Research and Development (B3142C), National Science Foundation - Integrative Graduate Education and Research Traineeship program (DGE 0333420).

1.0 INTRODUCTION

Choice of a suitable wheelchair requires serious consideration. The U.S. Food and Drug Administration (FDA) recommends testing of wheelchairs using American National Standards Institute (ANSI) / Rehabilitation Engineering and Assistive Technology Society of North America (RESNA) testing standards [1] to assess performance, safety and estimate life expectancy of a wheelchair. Results from ANSI/RESNA standard tests are a source of information about technical quality, performance, and allow comparison of results across devices. The content of the standard tests covers many aspects that would affect wheelchair usage and selection, such as dimensions, static stability, braking effectiveness, strength, and durability. Dimensions, weight, and turning radius clue consumers whether a wheelchair will fit in their home, working environments, and transportation means. Wheelchair performances in the static stability tests reveal the estimated behavior of the wheelchair on an incline. The results indicate how the stability of the wheelchair is effected by adjustment of the axle and other components. It is difficult to tell the strength and durability from the retail advertisements and user manuals. Although medical insurers' prescription guidelines typically require a 3-5 year duration before a replacement wheelchair will be covered, previous research shown that the predicted life expectancy of some wheelchairs is significantly less [2-7]. Premature failure of the wheelchairs could potentially injure the users, and may require them to pay for replacements, which can cost several thousand dollars. According to Smith et. al [2], wheelchair users expect wheelchairs to improve their quality of life and help them maintain or achieve a desired level of mobility. Users

expect their wheelchairs be comfortable, easy to propel, safe, and good-looking [2]. In a survey of wheelchair users with amyotrophic lateral sclerosis, the most desirable features of manual wheelchairs were a light-weight frame and a small turning radius [3]. Comfortable propulsion and support, light-weight, and small dimensions are very important features, especially for active manual wheelchair users [4, 5]. A lighter wheelchair has lower rolling resistance, which reduces the forces required to propel a wheelchair. Thus, lighter wheelchairs are suggested for preventing upper limb function of manual wheelchair users[6]. Developing a lighter and a more functional wheelchair is a goal for the design of many manual wheelchairs. The titanium wheelchair is a product in response to this goal.

ANSI/RESNA standard tests provide specific testing protocols to evaluate performance and durability of wheelchairs, and serve as a universal platform for data collection and comparison. There are reports using ANSI/RESNA standards to evaluate aluminum ultralight wheelchairs, and steel light-weight wheelchairs. Ultralight weight wheelchairs lasted more than five times as long as light-weight wheelchairs before catastrophic failures occurred during fatigue tests [7, 8]. However, ultralight wheelchairs experienced more repairable component failures, such as bolt or caster stem failures and screws loosening. Although replaceable component failures did not damage frame integrity, multiple component failures require frequent maintenance and may place the user in hazardous situations.

Many ultralight wheelchairs have titanium frames and/or components. Since titanium has a higher strength-to-weight ratio than aluminum, if engineered correctly, it could preserve the strength of the wheelchair frame, while lowering the weight. Conventional wisdom in our wheelchair clinic has been that people who use titanium chairs benefit from their highly durable and light-weight properties, although no standard test results of titanium wheelchairs has been

reported in the literature. Our goal in this study, similar to prior works in this area, was to test a series of commercially available titanium rigid frame wheelchairs using ANSI/RESNA testing procedures. The standard test to determine brake effectiveness according to International Standards Organization (ISO) was incorporated in this study [9] since there is no brake effectiveness test for manual wheelchairs in the current version of ANSI/RESNA standards. We hypothesized that these titanium wheelchairs would be in compliance with ANSI/RESNA standards, and that they would be more durable than previously tested aluminum ultralight wheelchairs and light-weight wheelchairs.

2.0 METHODS

2.1 STUDY WHEELCHAIRS

Twelve titanium rigid frame wheelchairs representing four models (Figure 1) from three manufacturers were tested using ANSI/RESNA wheelchair standard tests in this study. They were the most popular titanium ultralight rigid frame wheelchairs prescribed in the Center of Assistive Technology of the University of Pittsburgh Medical Center. They were ordered with the same seat dimensional specifications and their standard components respectively. Due to the cost and time to test wheelchairs, we only tested three wheelchairs for each model.

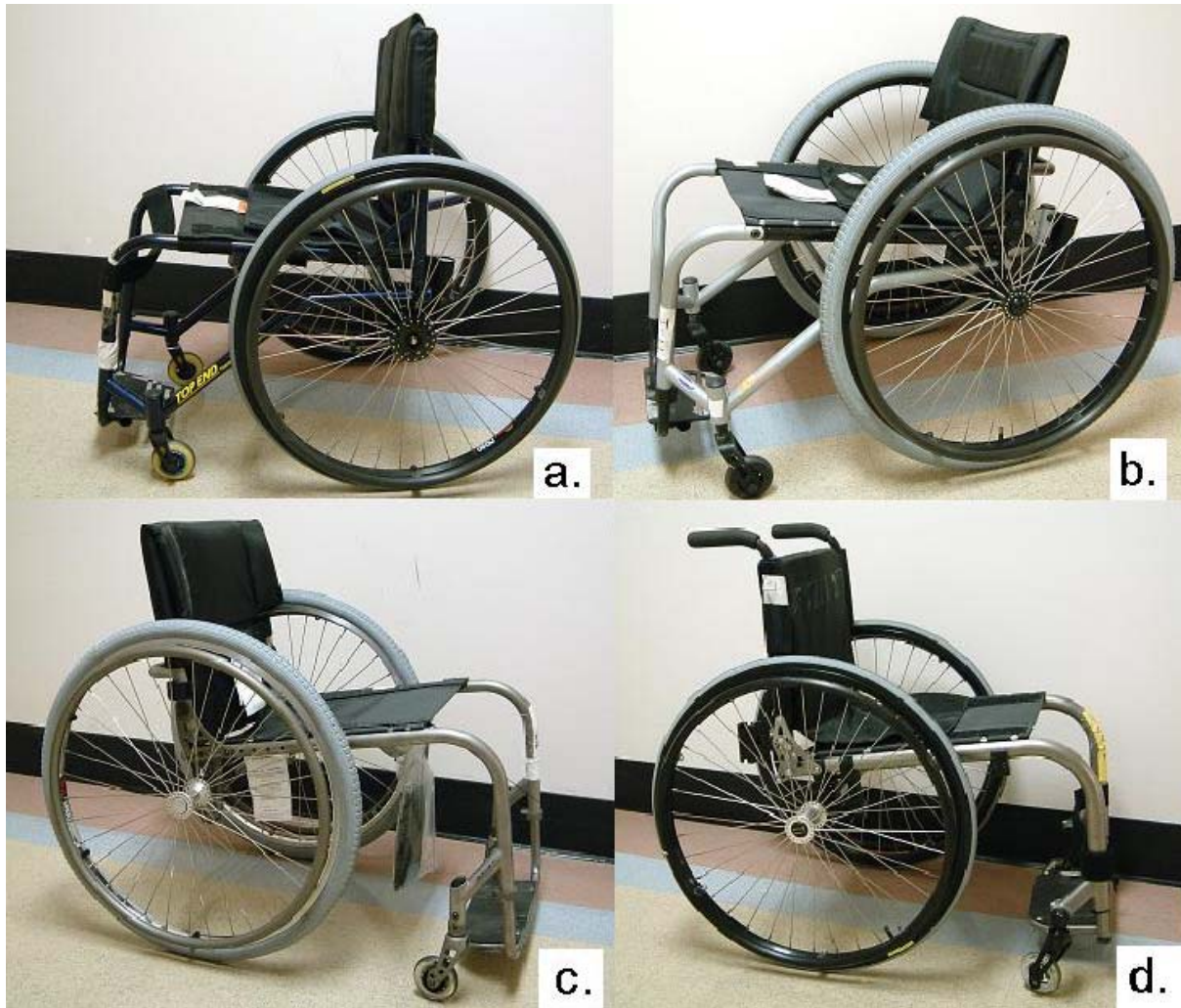

Figure 1. Four models of the titanium ultralight wheelchairs in this study. a. Invacare^a-TopEnd, b. Invacare^a-A4, c. Quickie^b-Ti, and d. TiLite^c-ZRA.

2.2 STANDARD TESTING PROCEDURE

2.2.1 General

We completed the whole battery of the manual wheelchair standard tests of ANSI/RESNA, and assessed brake effectiveness using ISO standard tests. This paper focuses on the test results of Static Stability, Brake Effectiveness, Static, Impact, and Fatigue Strength. The dummy used in this study was built according to the requirements of ANSI/RESNA standards.

2.2.2 Static Stability

The wheelchairs were tested in their most and least stable configurations (forward and rearward directions) in the Static Stability Tests (§1 in ANSI/RESNA Wheelchair Standards). A 100 kg dummy was loaded into the test wheelchairs. The wheelchair was secured on a platform using straps without interfering with tipping movement. An engineer increased the platform angle slowly and recorded the angle when the front casters lifted from the platform just enough for a piece of paper to pass between the casters and platform. In the rearward stability tests with the rear wheels locked, locking was implemented using parking brakes or securing the wheels with straps that limited the rolling motion of the wheel relative to the frame. In the other portions of the static stability tests, blocks or brackets that would not impede the rolling motion of the wheels were used to stop the wheelchair from rolling downhill.

The least stable position in rearward direction was acquired by moving the rear-wheel axle forward, reclining the backrest backward, and increasing the front seat height by adjusting the caster position. We went for the extremely least stable position since there was no indication or limitation on the wheelchairs or in the users' manuals. Most of the wheelchairs in their least stable setting tipped backward on a horizontal plane with the dummy loaded. Although these extremely unstable positions in rearward direction were not realistic wheelchair setting, we still proceeded and recorded the tests because the purpose of having the standardized tests is to reveal actual properties of a wheelchair. To address this, we modified the testing procedure by placing the wheelchair facing downhill on the level platform and securing it with straps to prevent it from tipping over completely (a. in Figure 2). The slope was then increased, and the angle was recorded when the front casters touched the platform (b. in Figure 2). The reading was a negative number.

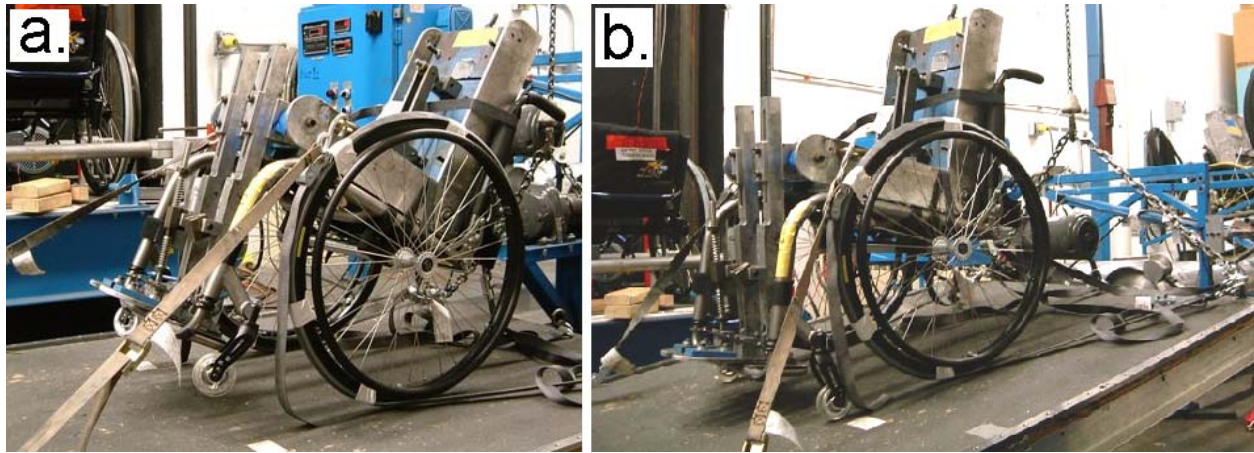

Figure 2. Rearward stability test with the wheelchair in the least stable configuration and rear wheels locked. All of the rearward stability tests with the wheelchairs in their least stable settings had the same modified testing method. The wheelchair was placed facing downhill and secured by straps to prevent it from tipping over completely, while gradually increasing the angle until the front casters touched the platform (a.). The angle was recorded when the front casters touched the platform (b.).

2.2.3 Braking Effectiveness

In the Braking Effectiveness Tests (§3 in ISO Wheelchair Standards), we kept the wheelchairs in the same setting as when they came out of the box (the axle was in the most rearward setting), loaded them with a 100 kg dummy, and engaged the rear brakes. The tests were performed on the same platform as in the static stability tests. While increasing the slope of the platform, the angle was recorded when the wheelchair started to slide downhill. The wheelchair was tested in its forward and rearward orientation. Since the steepest slope that fulfills the requirement of Americans with Disabilities Act (ADA) is 7° (1:8) with a maximum rise of 75 mm (3 inches) for

existing building and facilities, we expected that the wheelchair should be able to stay stationary on a 7° slope.

2.2.4 Static, Impact and Fatigue Strength Test (Durability Testing)

Static, Impact and Fatigue Strength Tests (§8 in ANSI/RESNA Wheelchair Standards) evaluate the strength of the wheelchair structure by applying different types of loads on specific components. A pneumatic ram was used to apply static force to the footrest, armrests, and tipping levers (if present) according to the standard. Impact force was applied using a pendulum on several components of the wheelchairs (footrest, caster wheels, push-rim) prone to impact objects. Any permanent deformation or component failure was considered a failure as denoted in the standards.

Fatigue strength was evaluated by the double-drum and curb-drop tests. The wheelchair was loaded with a 100 kg dummy during the tests. In the double-drum test (DDT), the position of the drive wheels was set at the mid-axle position according to the requirements in the standards. Because these titanium wheelchairs were unstable in this position, we set the rear axle in the most rearward position horizontally and in the mid-position vertically (which was how it arrived from the supplier). Other wheelchair settings were set according to the requirements in the standard. The leg length of the dummy was adjusted to fit the wheelchair dimension, and the feet were fixed on the footrests. The dummy's trunk and legs were secured to the wheelchair, although hip-joint motion was preserved through a spring-loaded damper system to allow physiologic-like motion during the testing. According to the standard, the dummy was positioned centrally on the seat. Generally, the weight of both legs is 32% of bodyweight [10].

Individual who are 6 months post spinal cord injury may lose 15% to 46 % of muscle cross-sectional areas over lower extremities [11]. We kept weight loading on the front casters carefully within 20-25% of the total weight including the dummy and the wheelchair to approximate the influence by the occupant's bodyweight and the weight of the wheelchair and prevent over loading onto the casters. This was achieved by adjusting the location of the dummy anteriorly or posteriorly. The 12-mm-high slats on the drum simulate sidewalk cracks, door thresholds, potholes and other small obstacles on the rolling surface. Two clamps attached to the axle of the rear wheels held the position and balance of the wheelchair on the double drum machine, but allowed vertical movement without appreciable sideward drifting (Figure 3). The rear drum runs with the speed of 1 meter/sec, and the front drum turns 7% faster to vary the frequency of when the front and rear wheels encounter the slats. A wheelchair that completed 200,000 cycles on the test machine was considered passing the DDT.

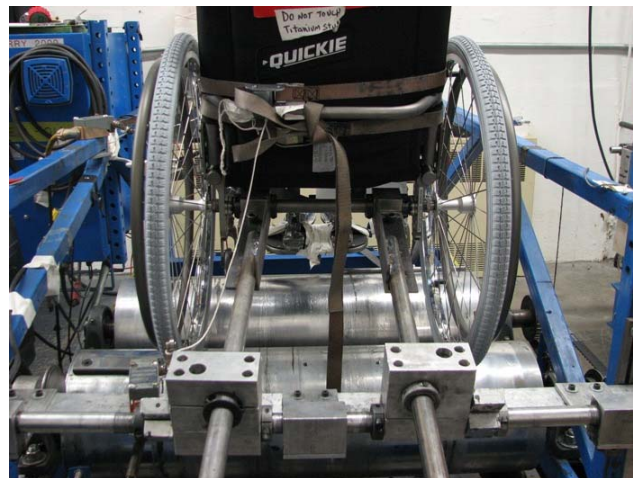

Figure 3. Setting of the double drum test. The two clamps attaching the axle of the rear wheels held the position and balance of the wheelchair on the double drum machine, but allowed vertical movement without appreciable sideward drifting.

Only the wheelchair that passed the DDT would continue the curb-drop test (CDT). In the CDT, the wheelchair was dropped freely from a 5 centimeter height repetitively onto a concrete floor to simulate a wheelchair going down small curbs. A wheelchair passes the wheelchair standard tests when it survives 200,000 cycles in the DDT and 6,666 cycles in the CDT without harmful damage [1]. The intensity of the fatigue tests mimics 3 to 5 years of daily use[12]. We repeated the fatigue tests until each wheelchair had permanent damage to reveal the exact survival life. For the purpose to compare the fatigue life, the following formula was used to compute the equivalent number of cycles [7, 13, 14]:

$$\text{Total Equivalent Cycles (EC)} = (\text{Double-Drum Tester Cycles}) + 30 \times (\text{Curb-Drop Tester Cycles})$$

[Equation 1]

The EC counts the number of cycles before the occurrence of the Class III failure in the Fatigue test. A wheelchair that obtained an equivalent cycle of 400,000 cycles was denoted as passing the minimum requirements of the standard.

The severity of the failure was classified into three levels. Any failures that could be repaired by the user or any untrained personnel such as tightening screws or bolts or inflating the tires was counted as a Class I failure. Class II failures need to be repaired by a wheelchair or bicycle technician, such as replacing tires or spokes and doing complex adjustments [12]. Permanent damage of the frame or any failure that would put the user in a hazardous situation was counted as Class III failures in this study. In a previous ultralight wheelchair comparison study, three bolt failures were considered a Class III failure [7]. Multiple minor failures were not counted as a Class III failure in this study to prevent premature discontinuation that would

shelter the durability of the main frame and structure. All the failures were recorded to disclose the frequency and complexity of the repairs needed for each wheelchair.

2.3 COST EFFECTIVENESS

It is meaningful to know the cost effectiveness of a wheelchair. The cost-effectiveness of our test wheelchairs was compared using the value derived from normalizing the number of equivalent cycles by the retail price of the wheelchair (cycles/\$). The higher the value, the more cost-effective the wheelchair is deemed to be [8].

2.4 DATA ANALYSIS

Primary analysis for static stability, braking effectiveness, equivalent cycle, and cost effectiveness were done by Kruskal-Wallis followed by Mann Whitney U tests as a univariate analysis with levels of significance of $p < .05$. Non-parametric statistical methods were used because the data were not normally distributed and the sample size was small [15].

Survival analysis using the Kaplan Meier method was used to compare cumulative survival rate [13] of titanium, ultralight, light-weight, and depot wheelchairs. A class III failure was defined as the terminal event in each group of wheelchairs [13].

3.0 RESULTS

The general features of the wheelchairs are presented in Table 1. All the chairs were rigid frame with one pieced footrests.

Table 1: Overall Dimension and Feature of Titanium Wheelchairs

	Invacare-TopEnd	Invacare-A4	Quickie-Ti	TiLite-ZRA
Manufacturer	Invacare	Invacare	Sunrise Medical	TiLite
Rear Wheels and Size	Sunrims CR20 /610mm	SW6000 Sunrims /610mm	SW6000 Sunrims /610mm	Sunrims CR20 /610mm
Tires and Recommend Pressure	PRIMO V-TRAK/ 100 psi	(37-540) Pneumatic Tire Primo V-Trac Knobby / 75psi	(37-540) Pneumatic Tire Primo V-Trac Knobby / 75psi	PRIMO V-TRAK/ 100 psi
Caster Diameter (mm)	80	80	80	80
Mass (kg)	9.1	11.3	9.1	9.1
Overall Length (mm)	797	827	820	807
Overall Width (mm)	632	643	603	587
Seat Angle (°)	10.3	7.6-11.8	8.5-23.6	4.9-18.7
Backrest Angle (°)	14.0	2.1-14.6	5.2-22.2	2-21.3
Horizontal Location of Rear Wheel Axle (mm)	16.7-106.3	26.7-154.3	28.0-140.7	15.5-143.0

Horizontal Location of Rear Wheel Axle is the horizontal distance between the rear wheel axle and the intersection of the references of the backrest and seat plane according to the ANSI/RESNA Standards. All the horizontal rear wheel locations were forward from the intersection of the backrest and seat plane.

3.1 STATIC STABILITY

The average tipping angle and the standard deviation are shown in Table 2. Significant differences were found in two test sections: the forward stability test in the most stable configuration with wheels unlocked ($p=.025$), and the rearward stability test in the least stable configuration with wheels unlocked ($p=.047$). The Quickie-Ti was the most stable model in the forward stability test with the front wheels (casters) unlocked and in the most stable setting. The Invacare-TopEnd was the most stable model in the rearward stability test with the rear wheels unlocked and in the least stable setting.

Table 2: Mean Tilt Angle, Standard Deviation and Range of Tipping Angle in Static Stability

Tests

Model	Forward			Rearward					
	Front Wheel Unlocked			Rear Wheel Locked			Rear Wheel Unlocked		
	Least Stable	Most Stable	Range	Least Stable	Most Stable	Range	Least Stable	Most Stable	Range
Invacare-TopEnd	25.70± 0.61	26.90± 1.50	1.20± 0.98*	-1.27± 3.85	10.93± 0.23	12.20± 3.85*	1.00± 7.28*	20.33± 1.08	19.33± 8.35*
Invacare-A4	24.20± 1.77	31.97± 1.06	7.77± 1.55	-16.90± 8.18	10.63± 2.89	27.53± 5.37	-14.97± 2.88	20.93± 4.74	35.90± 5.96
Quickie-Ti	20.93± 1.82	34.33± 0.29*	13.40± 1.55*	-11.90± 1.61	14.57± 2.15	26.47± 2.90	-21.70± 6.01	27.07± 2.18	48.77± 4.31*
TiLite-ZRA	21.97± 0.38	31.43± 1.72	9.47± 1.60	-10.97± 2.71	10.10± 1.31	21.07± 1.44	-17.50± 3.12	18.27± 3.09	35.77± 1.32

Range is the difference in the tipping angle between most stable and least stable configurations.

*The result is significantly different from the other models.

The ANSI/RESNA wheelchair standards indicate to move the rear wheel position forward when conducting the forward stability test with least stable setting. When testing this group of titanium wheelchairs, the mid-position of the rear wheel axle was considered the least stable setting (a. in Figure 4) since the wheelchair would tip “backwards” if we moved the axle further forward (b. in Figure 4).

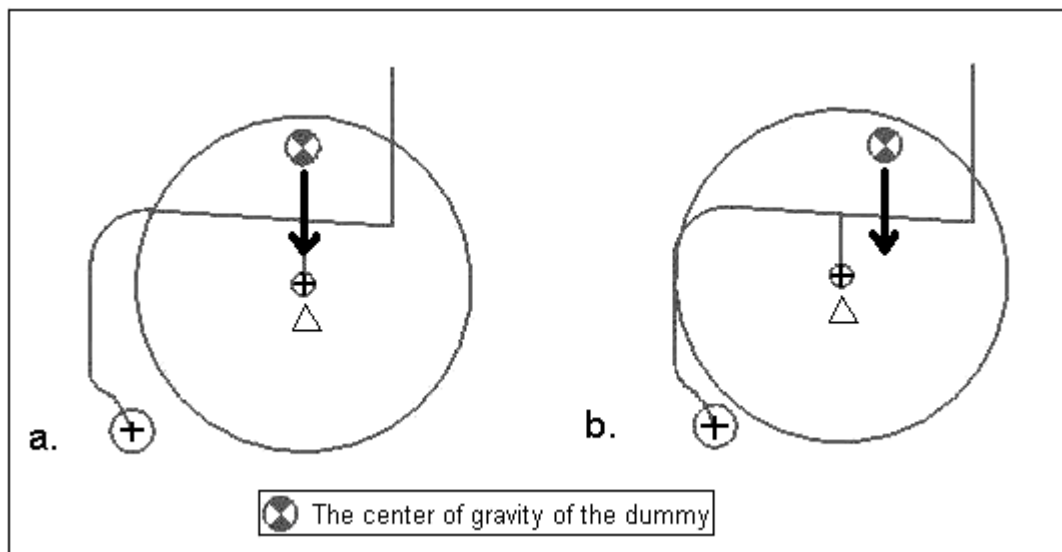

Figure 4. Position of the rearwheel axle in the forward stability tests. The mid-position of the rear wheel axle was considered the least stable setting (a) since the wheelchair would tip “backwards” if we moved the axle further forward (b).

The range in the last column of each section in Table 2 is the difference between the least and most stable tipping angle that indicates the adjustable variability of the center of gravity for a wheelchair. Significant differences were found among the four models in the forward direction with rear wheels unlocked ($p=.019$), the rearward direction with rear wheels locked ($p=.025$) and

the rearward direction with rear wheels unlocked ($p=.025$). The Invacare-TopEnd had the least range in the forward and rearward stability tests. The Quickie-Ti wheelchairs had the largest range in the forward and rearward stability tests with rear wheels unlocked. Difference of the tipping angle between the least and most stable wheelchair settings can give users and clinicians a general idea how much the center of gravity can be adjusted for the specific type of wheelchair (Table 2, range column).

3.2 BRAKING EFFECTIVENESS

The sliding angles in the braking effectiveness tests (forward and rearward) are shown in Table 3. No significant differences were found among the four models in the forward or rearward directions. Table 3 showed the individual data to reveal the performance of each wheelchair. All of the wheelchairs passed the forward braking test. Every chair in this study tipped backward without sliding in the rearward braking effectiveness test, and two chairs of each model tipped prematurely before the platform inclining to 7 degree.

Table 3: Sliding Angle in the Braking Effectiveness Tests

	Invacare-TopEnd			Invacare-A4			Quickie-Ti			TiLite-ZRA		
Wheelchair ID	03	04	05	06	11	12	07	08	09	01	02	10
Sliding Angle in Forward Brake Effectiveness Test	19.5	17.1	21.2	35	14.4	17.2	25.1	10	12.8	12	14	8.3
Sliding Angle in Rearward Brake Effectiveness Test	12.4	5.4*	4.2*	15	6.1*	3.1*	3.4*	9.4	5.6*	10	6.5*	5.9*

* The wheelchair tipped backward before the platform inclining to 7 degree.

3.3 IMPACT AND STATIC STRENGTH TESTS

All titanium wheelchairs passed the impact strength tests. There were two types of failure in the static strength tests. Two Invacare-TopEnd wheelchairs and one Invacare-A4 wheelchair failed due to deformation of the armrest mounting plates after a 760N downward force was applied on the armrests. This caused the undamaged removable armrests to bow outward which would impede the propulsion movement of the hands (a. in Figure 5). All of the handgrips of the TiLite wheelchairs slid off the push handles when a 750N backward pulling force was applied to the handgrips (b in Figure 5).

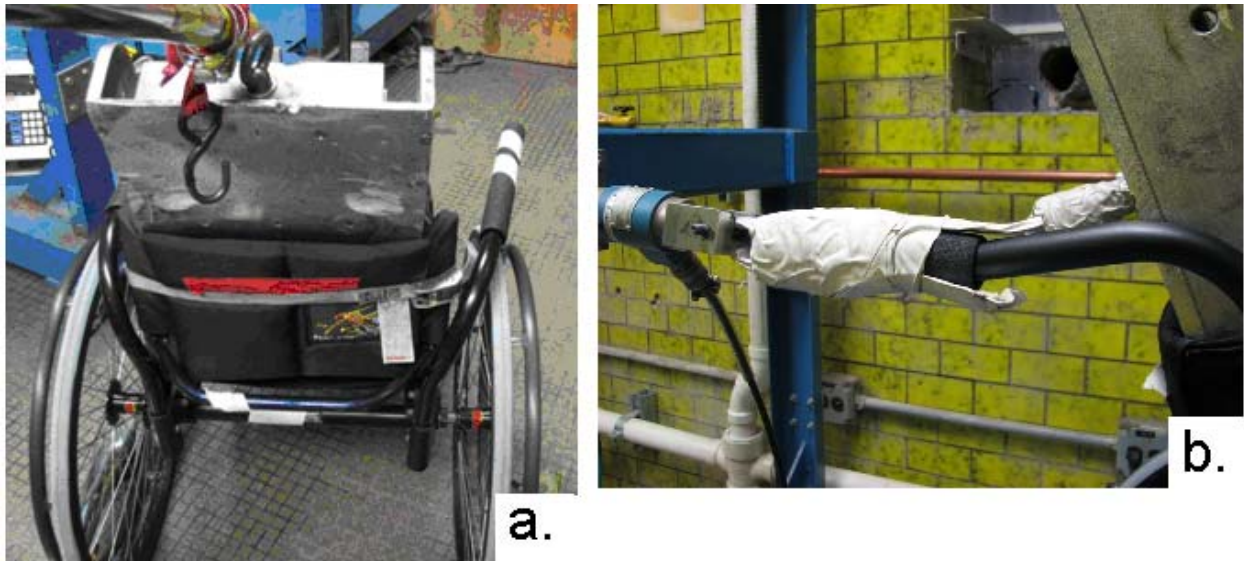

Figure 5. Two failures in the static strength tests. Picture a. shows the position of the armrest deviated due to the permanent deformation of the armrest mounting piece after a 760N downward force was applied on the armrest of an Invacare-TopEnd. The shifted location of the armrest would impede the propulsion movement of the hands. Picture b. shows that the handgrip slid off the handle after a 750N force was applied to pull the handgrip of a TiLite wheelchair backward.

3.4 FATIGUE STRENGTH TESTS (DURABILITY TESTING), EQUIVALENT CYCLES, AND COST EFFECTIVENESS

No significant differences were found in the number of the ECs among the four models. The Invacare-A4 had the highest number of mean equivalent cycles, and the TiLite-ZRA had the lowest number of ECs. The ECs and cost-effectiveness (in terms of value) of each model are shown in Table 4. Only four titanium wheelchairs out of twelve met the 200,000 cycle

requirement for the DDT. Two Invacare-A4 and one Invacare-TopEnd passed the wheelchair standard (Figure 6) (i.e. successfully completed the DDT and CDT). The titanium ultralight rigid frame wheelchairs had significantly less ECs than the aluminum ultralight folding wheelchairs ($p < .001$), but their ECs were not significantly different from those of the lightweight steel wheelchairs ($p = .569$).

The manufacturer suggested retail price of Invacare-TpoEnd was \$3,218, Invacare-A4 was \$2,875, Quickie-Ti was \$2,995, and TiLite-ZRA was \$2,695. The prices were for the configuration of the wheelchairs tested in this study. The Invacare-A4 had the highest value and the TiLite-ZRA had the lowest value (Table 4), but no significant differences were found among the four models. Compared with previous tested aluminum ultralight folding and steel lightweight wheelchairs, these titanium wheelchairs had significantly less value ($p < .001$ and $.006$ respectively).

Table 4: Mean Equivalent Cycles and Mean Value of the Titanium Manual Wheelchairs

Titanium MWC	Mean Equivalent Cycles ± Standard Deviation	Mean Value (cycles/\$) ± Standard Deviation
Invacare-TopEnd	218,945.7±186,128.9	68.0±57.8
Invacare-A4	390,097.7±191,420.4	135.7±66.6
Quickie-Ti	224,732.7±151,797.9	75.0±50.7
TiLite-ZRA	152,249.3±57,929.4	56.5±21.5

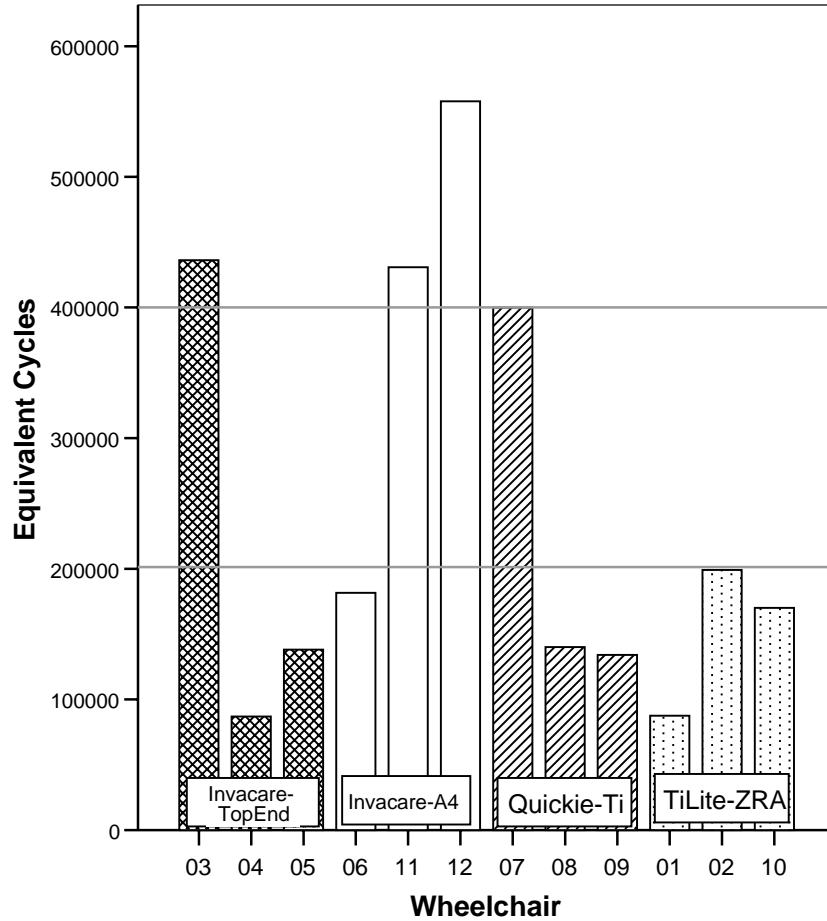

Figure 6. Equivalent cycles of each wheelchair in the fatigue tests. The horizontal line at 200,000 cycles indicates the required testing cycles in the double drum test. The second at 400,000 cycles represents the minimum requirement in the ANSI/RESNA wheelchair standard.

Numbers of Class I and II failures occurring before permanent damage are shown in Figure 7. Wheelchairs No.05, 06, and 08 had no Class I or Class II failures before the permanent frame failure occurred. The Invacare-A4 wheelchair No.11 and TiLite-ZRA wheelchair No.10 (TiLite-ZRA-10) experienced the highest number of failures (four times) before the final Class III failure. Three of the Class II failures of the TiLite-ZRA-10 were the spokes of the rear wheel, not a frame failure. If the wheel failures were not counted, eight wheelchairs experienced only

one or zero class I or class II failure before catastrophic frame failures occurred. Each minor (class I and II) and the permanent (class III) failure are listed in Table 5. The failure mode was relatively consistent within the model of the titanium wheelchair.

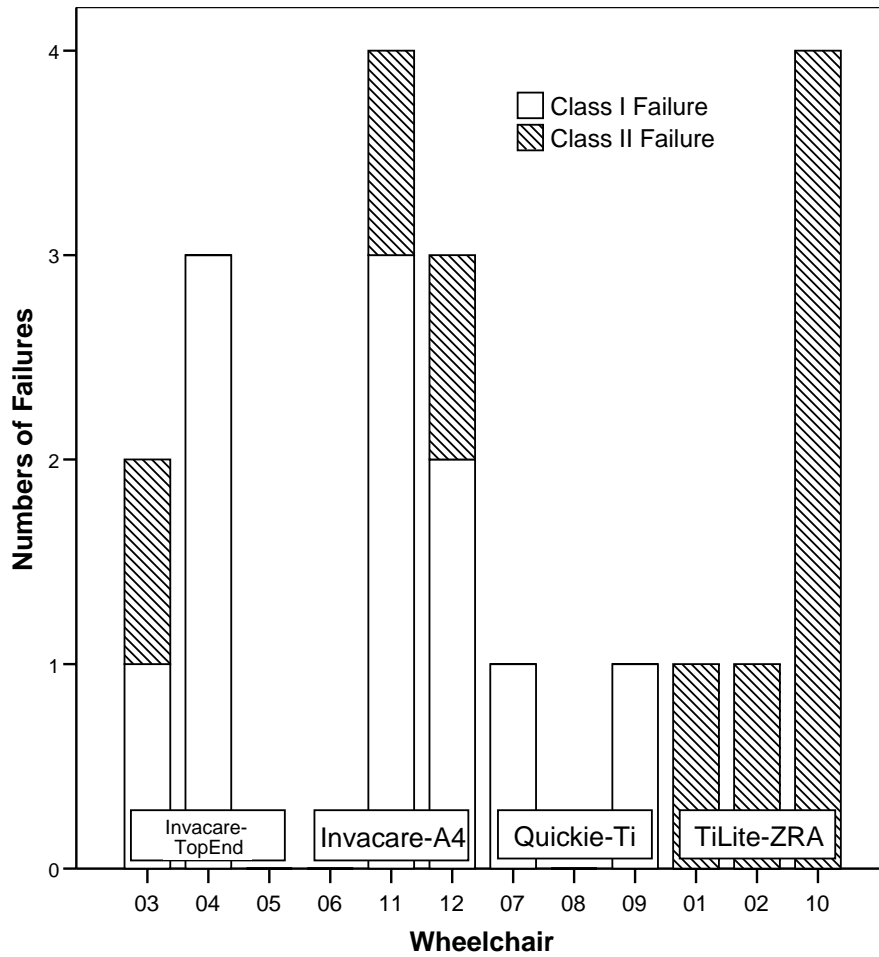

Figure 7. Numbers of Class I and Class II Failures before the Class III failure occurring during the Fatigue Tests

Table 5: Failure Mode in the Fatigue Tests

Wheelchair	Class I and II Failures	Class III Failures
Invacare-TopEnd-03	Right rear wheel axle screw slid out. Backrest upholstery was worn out.	Both backrest canes fractured.
Invacare-TopEnd-04	Right rear wheel axle screw slid out × 3 times.	Both backrest canes fractured.
Invacare-TopEnd-05		Left backrest cane fractured.
Invacare-A4-06		Right caster stem fractured. The frame fractured through the screw hole at the midway of the seat on right side. Both rear wheels could not be taken off from the quick release axle.
Invacare-A4-11	Footrest slid down. Rear wheel axle slid forward. Footrest left suspension tube fractured. Left rear wheel axle slid out.	Right frame tube fractured at the screw hole for the mounting piece between the backrest and seat.
Invacare-A4-12	Seat sling detached from the frame. Footrest slid down × 2 times.	Right frame tube fractured at the screw hole for the mounting piece between the backrest and seat.
Quickie-Ti-07	Left caster screw loosened.	Left frame tube fractured at the first screw hole of the seat.
Quickie-Ti-08		Frame tube fractured at the left first screw hole and was torn at the right second screw hole of the seat.
Quickie-Ti-09	Right caster screw loosened.	Left frame tube fractured at the second screw hole of the seat.
TiLite-ZRA-01	Plastic plate of the footrest chipped.	Right frame tube fractured at the first screw hole of the seat.
TiLite-ZRA-02	Plastic plate of the footrest chipped.	Right frame tube fractured at the first screw hole of the seat. Right rear wheels could not be taken off from the quick release axle.
TiLite-ZRA-10	Eight spokes of right rear wheel detached sequentially. Plastic plate of the footrest chipped.	Right frame tube fractured at the first screw hole of the seat.

4.0 DISCUSSION

4.1 GENERAL

Lighter weight and more compact dimensions can improve the maneuverability and transportability of a wheelchair [5]. This group of titanium rigid frame wheelchairs tends to have smaller dimensions and lighter weight than those of the wheelchairs with swing away footrests of the same seat dimensions. The titanium wheelchairs are expected to increase convenience and efficiency in daily living. However, the general features do not endorse that this group of titanium wheelchairs are the best choice for manual wheelchair users. There are multiple factors that affect satisfaction and usage of wheelchairs [4, 16].

The results of this study rejected our previous hypotheses that these titanium wheelchairs would be in compliance with ANSI/RESNA standards and more durable than previously tested aluminum ultralight wheelchairs and light-weight wheelchairs. Discussions according to the sections in the standard tests were provided as follows.

4.2 STATIC STABILITY

This group of titanium wheelchairs with rigid frames had a greater difference in tipping angles between the least and most stable settings in each stability test compared with the aluminum ultralight wheelchairs in our previous study [7]. The aluminum wheelchairs of folding frames with X bars and swing away footrests had the center of gravity in a more forward position compared to the rigid frame wheelchairs. The lower limb position of the dummy on the wheelchair may also make the testing results different from the previous study. In this study, the knees of the dummy were more flexed compared with the setting in our previous test with the aluminum ultralight wheelchairs. This position shifted the center of gravity backward and thereby decreased the rearward stability.

Although the setting of having negative tipping angles is not practical in real life, the result indicates that this group of wheelchairs had great variability in the adjustment of the center of gravity of the user/wheelchair system, relative to the axle position. Our results suggested that the stability of this group of rigid frame wheelchairs may change significantly by moving the axle position subtly. Suppliers and clinicians should check and adjust the rear wheel axle with caution, especially when providing service to novice users with this group of wheelchairs.

4.3 BRAKING EFFECTIVENESS

The wheelchairs in this study stayed stationary in forward direction on the slope which was steeper than the maximum incline degree of a slope required by ADA. However, most of the wheelchairs tipped on the slope less than 7° in the rearward braking effectiveness test. The frame design and the lower limb position of the dummy did play an important role in affecting rearward stability as we have discussed above. The compact size of the wheelchairs with rigid frames increases their maneuverability but decreases rearward stability. Users have to effectively adjust trunk posture (i.e. leaning into the slope) to compensate for displacement of the center of gravity when pushing any wheelchair of these four models uphill. Novice users should be taught to lean forward when pushing up a slope and lean into the backrest when rolling down a slope.

4.4 IMPACT AND STATIC STRENGTH TESTS

Although the three Invacare wheelchairs that failed in the static strength test on armrests were still usable, the compromised material strength of the mounting plate could cause a catastrophic failure (a. in Figure 5). The TiLite wheelchairs had similar mounting mechanism for the armrest as the Invacare wheelchairs, but they had a stronger structure with double plates to support an armrest bar, which may be why they passed this portion of the standards.

All of the TiLite wheelchairs failed in the static strength test on handgrips. The hazard will occur when an attendant is pulling the wheelchair backward with an occupant in it in order

to decrease the speed while moving forward or downhill on a slope. The attendant may have the tendency to fall backward if the handgrips slide off the push handles. Also, the situation may endanger the user who could roll away uncontrolled. Another threatening situation may be when an attendant is assisting with a wheelchair user descending a curb. The wheelchair may lose control or tip backward if the handgrips slide off the push handles.

4.5 FATIGUE STRENGTH TESTS (DURABILITY TESTS)

This group of titanium wheelchairs survived less ECs (their average EC was $246,506 \pm 154,086$) than was previously reported for aluminum ultralight wheelchairs, but their life expectancy was similar to that of the steel light-weight wheelchairs [7, 8]. Published results show that the aluminum ultralight wheelchairs lasted on average $1,009,108 \pm 782,960$ (n=12) equivalent cycles, and the light-weight wheelchairs lasted on average $187,370 \pm 153,013$ (n=9) equivalent cycles [8]. Although the results were different among manufacturers, the wheelchairs in each group had similar performances. According to the survival curves (Figure 8), each step going down indicates a class III failure of the wheelchairs from each group. With 400,000 equivalent cycles as the minimum requirement, 80% of the aluminum ultralight wheelchairs survived, but less than 40% of the titanium wheelchairs survived to comply with current standards. The aluminum ultralight wheelchairs lasted about 4 times longer than the titanium wheelchairs, and had a value of about 5.4 times higher than the titanium wheelchairs.

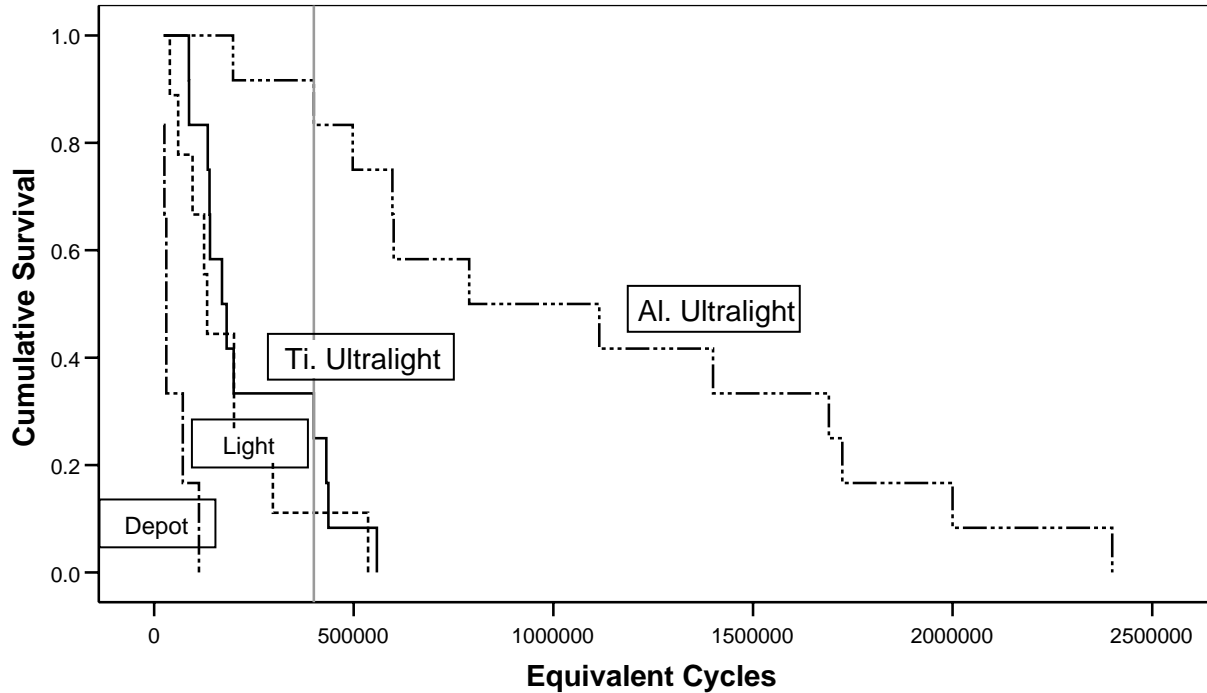

Figure 8. Survival curves for the titanium, ultralight, light-weight, and depot wheelchairs from this and previous comparison studies [7, 8, 17]. The gray vertical line indicates 400,000 cycles equivalent, which indicates passing the durability standard.

When comparing the coefficient of variation ($C_v = \text{standard deviation}/\text{mean}$) of the EC, the steel lightweight wheelchairs had a larger C_v (0.82) than the aluminum and titanium wheelchairs (0.67 and 0.66 respectively). This result may imply that the aluminum ultralight folding frame wheelchairs and titanium ultralight rigid frame wheelchairs were produced under better quality control than the steel lightweight wheelchairs.

In addition, this group of titanium wheelchairs exhibited less value than the aluminum ultralight and the steel light-weight wheelchairs (Figure 9). The aluminum and steel lightweight

wheelchairs were 11 times and 3.3 times more cost-effective than the titanium wheelchairs respectively.

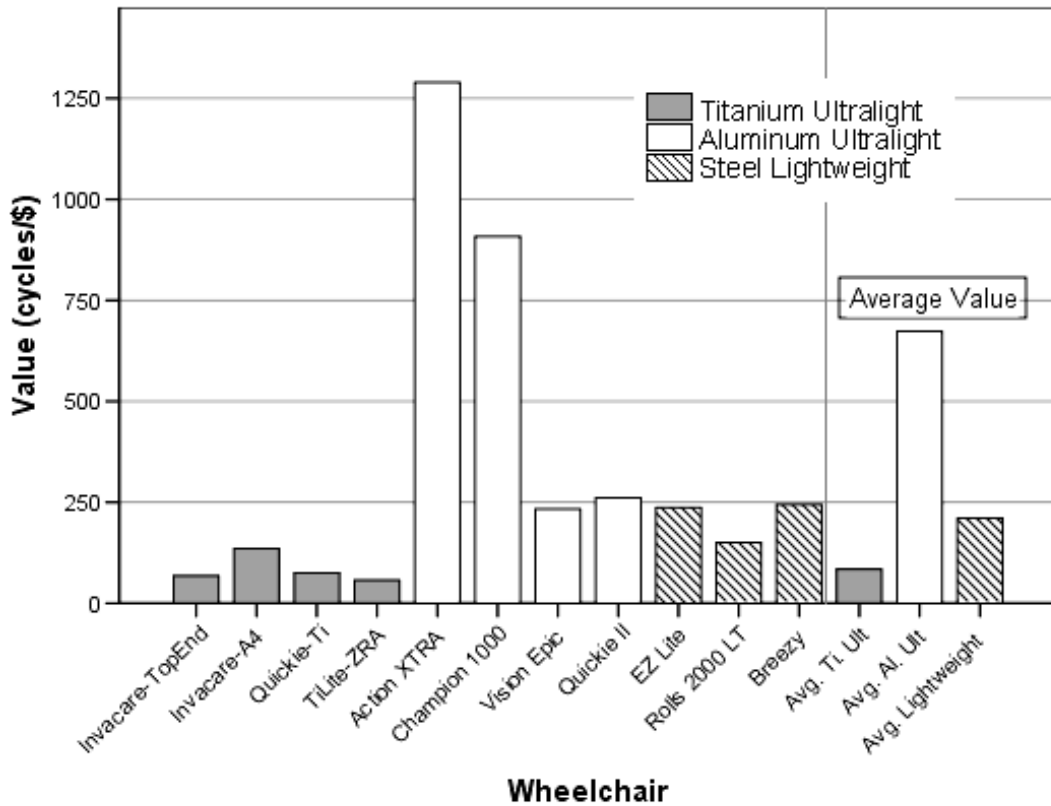

Figure 9. Value (cycles/\$) of the titanium, ultralight, and light-weight wheelchairs. The final three columns are the average value for the three types of manual wheelchairs, respectively. Standard deviation was also shown in each value.

All of the aluminum ultralight and light-weight manual wheelchairs were tested with 203mm solid casters, whereas the titanium wheelchairs had 80mm solid casters. The different caster size may be a contributing factor for some of the failures because larger caster diameter

decreases the impact forces when negotiating bumps, curbs, or holes, which may help the wheelchair to last longer.

Although a smaller caster size increases the impact loaded on the frame compared with 203mm casters on the previous tested aluminum wheelchair, it is reasonable to test these titanium rigid frame wheelchairs with 80mm casters. The 80mm casters are the standard components of the titanium wheelchairs in this paper. According to the clinical experience of the clinicians in the Center of Assistive Technology at the University of Pittsburgh Medical Center, most users of this group of wheelchairs were prescribed with these casters. Additionally, there is no option of having 203mm casters on these wheelchairs because the footrest and likely the users' feet would interfere with the free movement of these larger-sized caster wheels. If the testing results of a wheelchair with its standard components are not revealed, it may be difficult to estimate the quality and property of the wheelchair after adjustment or with modification.

The testing results of aluminum folding wheelchairs and titanium rigid frame wheelchair should be compared directly even though they had casters in different sizes. According to the clinical guideline [6], manual wheelchair users are recommended to use lighter wheelchairs without specific recommendation of caster size. Thus, manual wheelchair users at any level of injury or wheelchair skill may choose an ultralight titanium rigid frame wheelchairs tested in this study with 80mm casters or the ultralight aluminum folding frame wheelchairs with 203mm casters. Therefore, it is important that all types of wheelchairs should be tested with their various components to disclose their influence on performance of the wheelchairs, and all testing results of different types of wheelchairs should be directly compared to provide complete information for the consumers.

The minimum requirement of the standard in fatigue tests represents the durability of regular use for 3 to 5 years [12]. The titanium wheelchairs in this study had an estimated average usable life of 1.85 to 3.08 years. The Invacare and TiLite include a lifetime warranty and Quickie includes a 5-year warranty on the titanium frames. There seems to be a large discrepancy between the warranty provided by the manufacturers and the testing results in this study. In fact, the fatigue tests of ANSI/RESNA standards were conservative for this group of wheelchairs because the weight of the testing dummy (100 kg; 220 lbs) was actually less than the maximum weight capacity of the wheelchairs claimed by the manufacturers (113.6-136.4 kg; 250-300 lbs). To provide more reliable information to the consumers, the manufacturers should disclose the testing set-up and methods to determine the durability of their products.

4.6 FAILURE MODES

4.6.1 Invacare-TopEnd

All of the Invacare-TopEnd wheelchairs experienced fractures at the backrest canes. In temperatures higher than 500°C, titanium has a high affinity for oxygen, nitrogen, and hydrogen [18, 19]. Contamination by gas absorption can make titanium brittle, so the welding process must be protected from oxidation by an inert gas shield (argon or helium) or vacuum environments [18, 19]. When oxidation occurs, the oxide on the interacting surface may generate an interference color. On the Invacare-TopEnd-04, we found white, light blue, straw and gray colors in the weld vicinity on the inner surface of the fracture site (Figure 10). The

colors on the inner surface were within the heat affected zone, which indicates that the titanium had high levels of oxygen contamination during the welding process. The fracture surface in the picture is quite shiny and without plastic deformation which implies embrittlement which may have contributed to the fracture of the backrest cane.

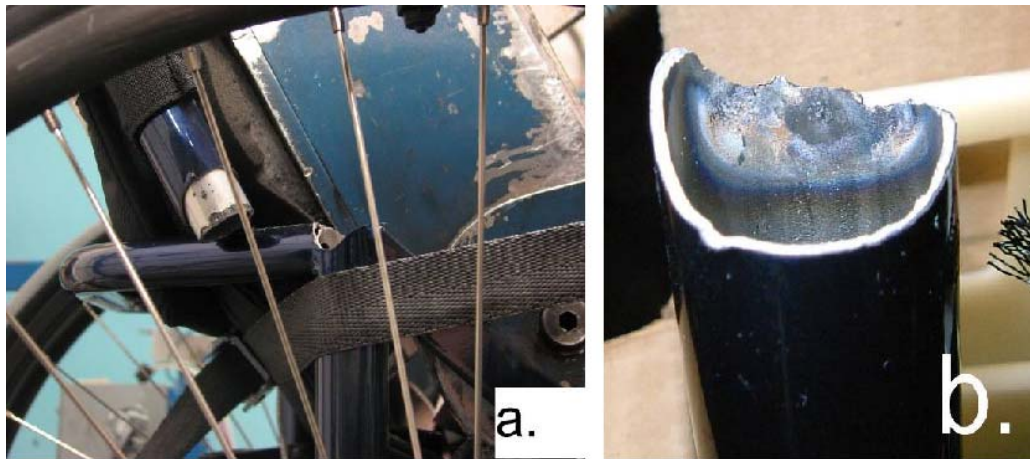

Figure 10. Backrest cane fracture of an Invacare-TopEnd wheelchair in the DDT. Picture a. shows the condition of the failure in the DDT with the dummy on the wheelchair. Picture b. shows the evidence of oxygen contamination that made the inner surface of the tube white, light blue, straw and gray.

Although we did not find clear evidence of oxygen contamination in the other two Invacare-TopEnd wheelchairs, they both fractured in the same area on the backrest canes around the welding site connecting the backrest cross-bar (a. in Figure 11) and the top corner of the gusset (b. in Figure 11). The backrest cross-bar is welded with the backrest cane on both ends to

increase the strength of the backrest. The gusset serves to reinforce the structure between the backrest and seat. By the anterior and posterior movement of the dummy hitting on the backrest during the double-drum testing, the superior area of the gusset was at the bending stress concentration point of the cantilever structure [20].

Additionally there is a hole at the intersection of the backrest and the backrest cross-bar (b. and c. in Figure 11). This hole is purposely applied for inserting the gas flow to prevent the oxygen contamination from welding, but one of the backrest canes fractured at the hole (c. in Figure 11). Discontinuity in metal acts as a stress riser that decreases the strength of the material. The other three fractured backrest canes were broken at the superior edge of the weld area at the cross-bar. Although the weld at this site is quite thin compared with the gusset and has less chance to destroy the physical properties of the titanium, the backrest cane tended to break along the upper rim of the weld circle with the cross-bar. Heat treatment from welding likely decreased the strength of the titanium cane.

The Invacare-TopEnd had the same wall thickness of the backrest cane as the Quickie-Ti and TiLite-ZRA (1.27mm), and was slightly thinner than the Invacare-A4 (2.29mm) (Table 6). Yet, the Invacare-TopEnd was the only model where all chairs fractured at the backrest canes. The four factors - the cantilever structure of the backrest, one weld area for the backrest cross-bar on the backrest, a second weld area for the gusset on the backrest, and the hole for inserting the gas shield - all contributed to weaken the structure. Only the depot wheelchairs in our previous comparison study had similar failure as the Invacare-TopEnd [17].

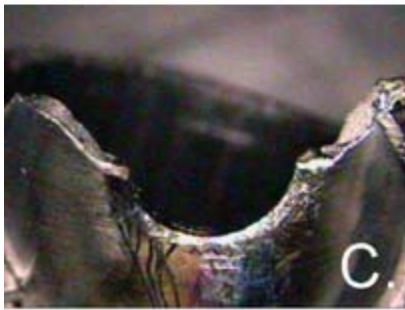

Figure 11. The structure nearby the fracture site of the Invacare-TopEnd wheelchairs. Picture A. shows the geometry relationship of the backrest cross-bar (a.) and reinforcing gusset (b.) with the backrest cane. B shows the position of the hole for inserting the gas shield. C shows one of the back rest cane fractured right at the gas insert hole.

Table 6: Dimension of the Frame Tubes and Backrest Canes

Unit: mm	Frame Tube			Backrest Cane	
	Diameter	Thickness	Outer Diameter of Footrest Tube	Diameter	Thickness
Invacare-TopEnd	25.65	1.27	22.35	25.65	1.27
Invavare-A4	25.65	1.27 [†]	19.05	25.65	2.29
Quickie-Ti	25.65	1.27	19.05*	25.65	1.27
TiLite-ZRA	31.75	1.52	19.05	25.65	1.27

* The inner diameter of the clamp for the footrest of the Quickie-Ti is 19.05mm.

[†] The thickness of the tube at the seat plane of the Invacare-A4 is 1.02mm.

We found that an Invacare-TopEnd wheelchair had different types of screws on the two front casters. Although the structural strength was not affected, this finding suggests a possible quality control problem.

4.6.2 Invacare-A4

The Invacare-A4-06 fractured at the right caster stem and the middle of the right tube in the seat plane in the first round of the double-drum test (Figure 12). The caster stem is steel. From the pictures b. and c. in Figure 12, the beach marks can be seen on the fracture surface that indicate the occurrence of metal fatigue [21, 22].

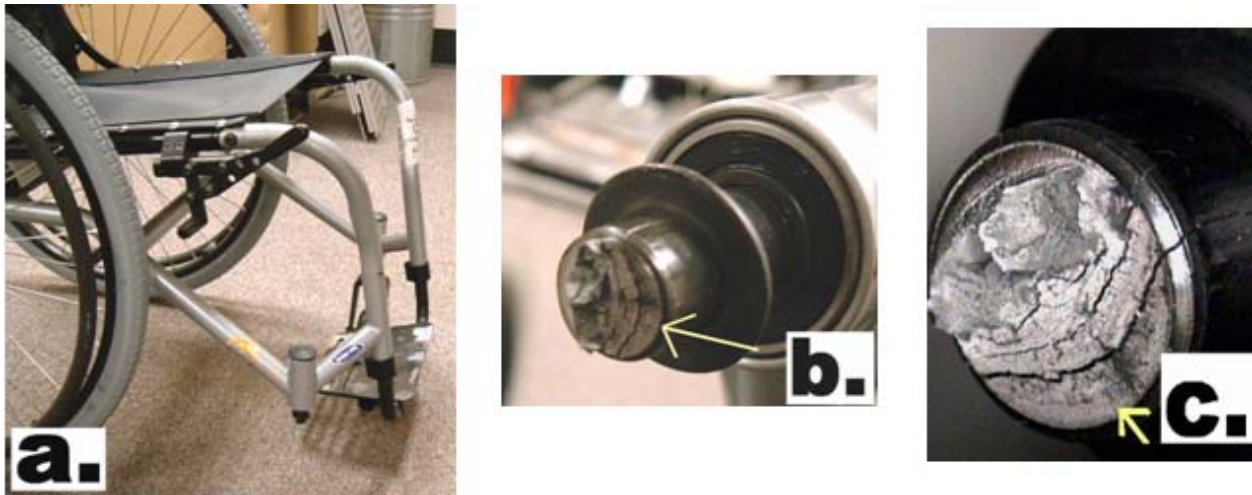

Figure 12. Caster stem fracture of an Invacare-A4 wheelchair. Picture a. shows the location of caster stem fracture. Pictures b. and c. show the fracture surface, and the arrows indicate the start of crack that eventually developed as fatigue fracture.

Around the fracture at the middle of the right seat frame of the Invacare-A4-06 (Figure 13), there were three holes at the superior, medial and lateral sites around the same location of the tube. The fracture line passed through the two holes on the medial and lateral side. In the drawing with translucent pattern in Figure 14, Circle a. indicates the fracture site at the frame of the Invacare-A4-06. The proximity of the holes in Circle a. decreased the strength of the structure.

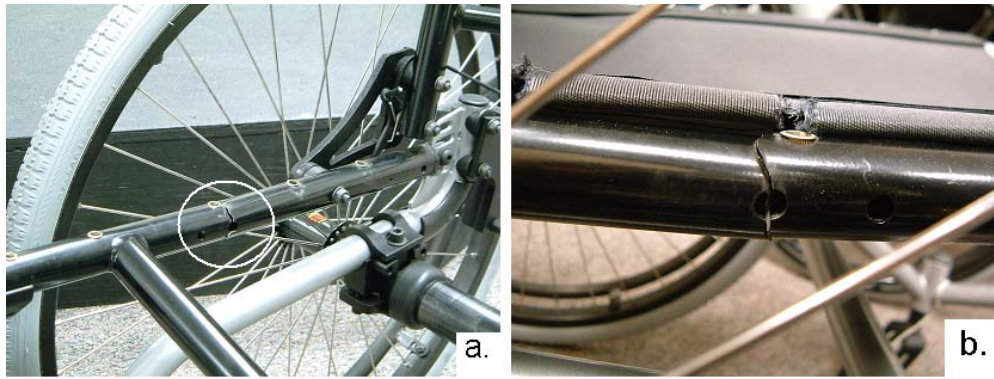

Figure 13. Fracture at the middle of the tube in the seat plane of an Invacare-A4. Picture a. shows the medial view, and Picture b. shows the lateral view. The fracture lines in Picture a. and b. were connected with each other.

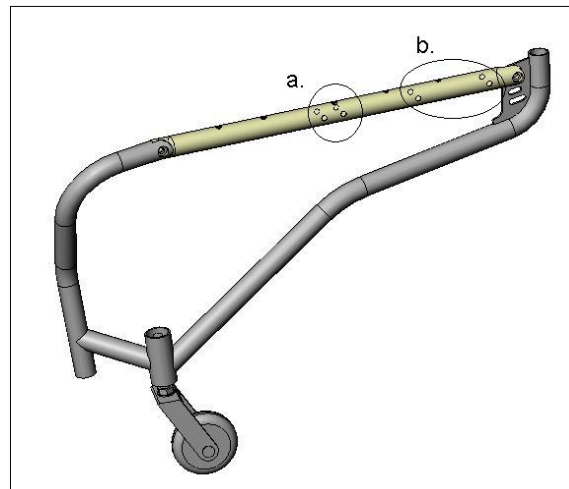

Figure 14. The left frame of the Invacare-A4 showing the locations of screw holes on the tube in the seat plane. Circle a. indicates the fracture site at the middle of the seat plane of the Invacare-A4 wheelchair with a caster stem fracture. Circle b. indicates the fracture site of the other two Invacare-A4 wheelchairs which went into the 2nd round of the DDT.

Both of the Invacare-A4 wheelchairs which passed the first round of the fatigue tests but failed in the 2nd round of the double drum test had fractures around the screw holes of the mounting plate between the backrest and seat frame and the screw holes for the seat sling (Figure 15). In addition to the screw holes for the seat sling (5 holes on the top of the tube) and the mounting pieces of the backrest (2 on the medial side and 2 on the lateral side) (circle b. in Figure 14), there are four more holes on the side (2 on the medial side and 2 on the lateral side) for the mounting bracket of the T-shaped armrest (circle a. in Figure 14). Although the Invacare-A4 was the model which had the most equivalent cycles among the four models of titanium wheelchairs, the aluminum ultralight wheelchairs performed much better in the fatigue tests in the previous ultralight wheelchair comparison study, where 6 of the 12 wheelchairs passed the second round of the fatigue testing [7].

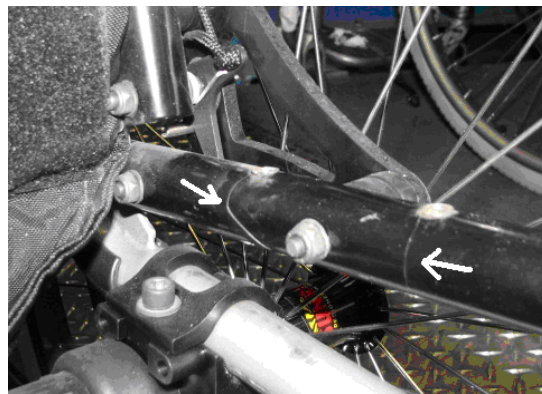

Figure 15. Fracture lines (arrows) around the screw holes for the mounting plate between the seat plane and backrest of an Invacare-A4 wheelchair.

The footrests of the two of the Invacare-A4 wheelchairs repeatedly slid down during the double drum test. The Invacare-A4 and TopEnd footrest tube is clamped by only a set screw (c. in Figure 16). Compared with the Invacare-TopEnd, the A4 had larger discrepancy in the diameter between the tube of the footrest and the outer piece of the main frame (Table 6) so that its footrest slid down easily under the weight of the dummy's legs during the double drum test. The set screw carved notches on the vertical footrest tube after repeatedly sliding (b. in Figure 16). Although this mounting mechanism of the footrest would not affect the integrity of the main frame, the unanticipated repositioning of the footrest can be inconvenient and potentially injurious.

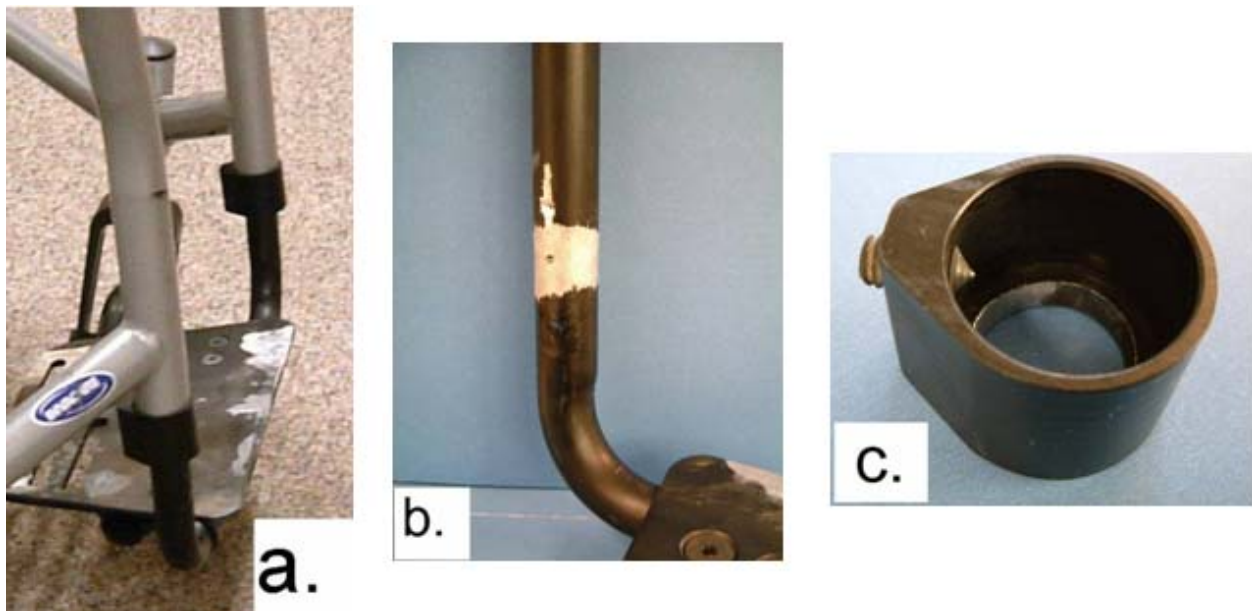

Figure 16. Footrest of an Invacare-A4 wheelchair. Picture a. shows the general structure of the footrest. Picture b. shows the scratch by the set screw on the vertical footrest bar. Picture c. shows the structure of the clamp and the set screw.

4.6.3 Quickie-Ti and TiLite-ZRA

The Quickie-Ti and TiLite-ZRA wheelchairs had the same type of failures, either at the first or second screw holes near the front of the seat sling which are used to mount the sling to the frame (Figure 17). Both models use a cantilever frame (Figure 18A). Comparing with a box frame (Figure 18B), a cantilever frame does not have the lower longitudinal tubes. When running on the double drum machine, the slat on the drum applied a force (a. in Figure 18A) to the frame when impacting the casters. The force (a. in Figure 18A) produced a bending torque (b. in Figure 18A) and tended to bend the front vertical part of the frame rearward. The bending torque transmitting to the corner of the frame would compress the lower part of the tube (c. in Figure 18A) and extend the upper part of the tube (d. in Figure 18A). The first and second screw holes on the upper part of the tube were just rearward to the frame bend and acted as a stress concentration. Therefore, the fracture occurred inevitably at the first or second screw hole on the seat tubes.

The TiLite-ZRA and Quickie-Ti had the same frame design and similar locations of the screw holes on the seat tubes resulting in identical failure modes. The frame tube of the TiLite-ZRA had a greater wall thickness and larger diameter than the other models (Table 6). Even so, the location of the screw holes decreased the durability of the wheelchair as shown in the results of the fatigue tests.

In the box frame design (Figure 18B), the lower longitudinal tube helped to distribute the force transmitted to the casters (c. in Figure 18B). This decreased the bending torque on the

frame (b. in Figure 18B). The Invacare-A4 had screw holes near the corner of the front frame as well, but the lower stresses helped protect the chair from failure at these stress concentration locations. There are alternative ways to fix the seat sling onto the frame other than using screws. For example, the Invacare-TopEnd Terminator Everyday Rigid Wheelchair uses Velcro straps to attach the seat sling [23], which may have ameliorated the premature failures

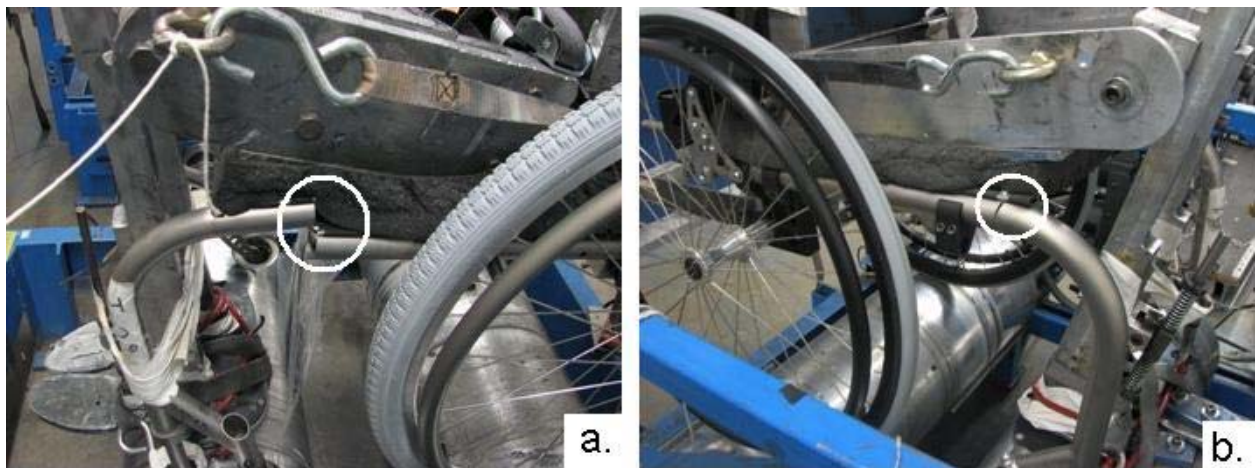

Figure 17. Fracture in the frame tube of the wheelchair having cantilever structure along the seat plane to footrest. Picture a. is the fracture of a Quickie-Ti chair at the second screw hole on the left front frame. Picture b. is the fracture of a TiLite-ZRA chair at the first screw hole on the right front frame.

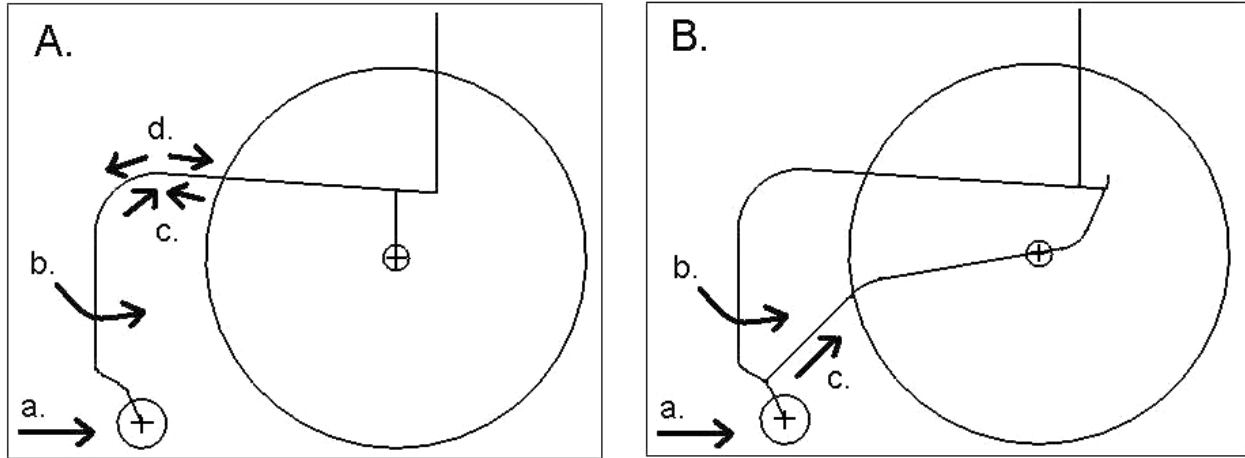

Figure 18. Structure comparison between the cantilever frame (A.) and box frame (B.). For both types of the frames, the force (a.) created a torque (b.) that tended to bend the front vertical part of the frame. In the cantilever frame, the force transmitting to the frame tube compresses the lower part of the tube (c. in A) and stretches the upper part of the tube (d. in A). The first and second screw holes on the upper part of the tube are a stress concentration and contributed to premature failure. The box frame has lower longitudinal tubes which help to distribute the stress (c. in B) from the force a. thus decreasing the bending torque at the vertical front part of the frame.

Titanium alloys have 44-66 MPa-m^{1/2} plane strain fracture toughness (K_{IC}) higher than aluminum alloys (29 MPa-m^{1/2}) [22]. Fracture toughness is the resistance of the metal to brittle fracture when a crack is present. The metal with lower K_{IC} is more vulnerable to brittle fracture. (The actual fracture toughness of a specimen with the thickness less than a critical value, which reflects the condition in this paper, should be evaluated with plane stress. Yet, plane strain is most frequently cited when comparing fracture toughness.) On the other hand, titanium has a

higher yield strength 910 MPa than Aluminum (505 MPa) [22]. To withstand the same bending force as the frame tube of most wheelchairs in this study (the tube diameter is 25.65mm, and wall thickness is 1.27mm), an aluminum tube of the same outer diameter has to have the least wall thickness of 2.73 mm. Therefore, the volume of an aluminum tube has to be at least 2.02 times more than the titanium tube. (The information above was calculated according to the formula: bending stress of a tube = (Force × Length) / (I / (0.5×OD)), $I = \pi \times (OD^4 - ID^4) / 64$, OD=outer diameter, ID=inner diameter.) Although titanium has desirable mechanical properties, titanium is 1.6 times heavier than aluminum per unit volume, which makes an aluminum tube from the calculation above weights 1.3 times heavier than a titanium tube. Balance between the total weight of the product and the structural strength needed to insure the durability of wheelchair usage should be considered carefully. Based on our results, frame design, caster size, and the quality of welding process are also contributing factors that would affect the durability of a wheelchair. Manufacturers and designers need to evaluate titanium wheelchair designs in greater detail in order to understand the impact of material choices, structural design and manufacturing process on the strength, durability, and function of the wheelchair.

4.7 LIMITATIONS

First, the sample size is a limitation of this study. We would have to test 12-60 wheelchairs of each model to have statistical power of 0.8 according to the testing results in this study. It is not realistic to spend the time span and the money to test the required amount of wheelchairs.

Second, a testing dummy can not precisely simulate a real wheelchair user. A real wheelchair user could adjust postures dynamically and avoid the situation that may endanger him/herself or the wheelchair. For example, repeated impact from the dummy's trunk during the fatigue tests may not occur in real situations with this group of wheelchairs. It is not uncommon for some users to hang their backpacks on backrests which may also develop bending stress on the backrests. Moreover, the testing dummy weights (100 kg; 220 lbs) less than the maximum weight capacity of the wheelchairs (113.6-136.4 kg; 250-300 lbs) in this study. Therefore, the standard fatigue tests are conservative for these wheelchairs. Although the test dummy does not completely mimic a real wheelchair user completely, the general physical properties of the dummy is actually producing less stress on the wheelchairs than the manufacturers claim their wheelchairs will be able to sustain.

Another limitation is that ANSI/RESNA standard tests were originally designed to test K0001 wheelchairs ten years ago, thus the original requirements may not reflect the demand on the technology and manufacturing quality of today's K0005 wheelchairs. Regardless, we expect that due to wheelchair skills training and lighter-weight wheelchairs, the devices are subjected to very rigorous activity and abuse. Additionally, because ANSI/RESNA is an industry standard, and evolves according to the standards development and revision process, it is important to continue to use them and report results, even if they are subject to criticism.

Finally, we could only draw general results from standard tests. The information was not enough to thoroughly discriminate the specific causes or mechanisms attributed to the vital failures in the fatigue tests. Therefore, future studies are needed to address this issue.

4.8 FUTURE WORK

4.8.1 Mechanical Engineering of Wheelchair Design

Durability and Fatigue Failure Mode

The results of this study revealed controversial failure modes in the fatigue tests of titanium wheelchairs. Multiple factors were present within each titanium wheelchair design, including caster sizes, frame structures, and welding locations. The impact of each factor is difficult to distinguish. In order to verify the impact of each factor, we have begun testing a series of aluminum wheelchairs with similar frame designs. By comparing the variances within equivalent cycles of each model and the aluminum wheelchair study, we hopefully will reveal some of the quality control issues. More practical guidelines for interpreting the test results of the ANSI/RESNA standards should be developed to promote good quality control in manufacturing.

Static Stability

Adjustability of the center of gravity was an interesting outcome in this study. Wheelchair users are encouraged to have the rear wheel axle as forward as possible to improve propulsion efficiency and prevent repetitive injuries [24, 25]. Titanium wheelchairs have a large range that the rear wheel axle can be adjusted forward, but there is no detailed instruction in users' manuals, and the adjustment range in the forward direction is too large. In the most forward

position, the wheelchair is too tippy for anyone to use. As tips and falls in the backward direction are common adverse events among manual wheelchair users[26], there is the need for developing a model to determine a proper position of the rear wheel axle. There needs to be a better understanding of the balance between maximizing propulsion ergonomics and maintaining rearward stability by adjusting the rear wheel axle. The manufacturers should provide clearer instruction about setting the axle position. A wheelchair should have a structural stop to prevent the rear axle from moving forward out of the safe range during axle adjustment.

In 1999, Kirby and Dupuis conducted a study applying the ISO wheelchair standards testing method to clinically measure the static rearward stability of occupied wheelchairs [27]. They concluded that employing the ISO testing method in the clinical setting was practical. However, the stability of the system may change according to different wheelchair frames and body positions. Although the study reported cutoff tipping angles to define if the wheelchair setting was stable, the authors did not recommend the use of the cutoff values in the clinical setting. Besides the measured rearward stability, there are more factors, such as wheelchair users' skill, strength, trunk control, and weight distribution in a chair, which increase the risk of tipping accidents.

Information on the stability of occupied wheelchairs needs to be updated. A shorter method with less equipment to evaluate stability in the clinic would be a valuable tool. Currently, the equipment to conduct the ISO static stability tests may not be available in the clinic. Additionally, safety is an issue while performing the tests with real clients on a tilted platform. Although the relationship between the rear wheel axle position and the tipping angle can be calculated using real wheelchairs and wheelchair users [28], developing a computer model to generate a suggested rear wheel axle position may be a more efficient method to benefit

clinicians and wheelchair users. In the meantime, the correlation between the users' opinion about their wheelchair stability as compared to wheelchair settings as suggested by research results needs to be investigated.

4.8.2 Injury and Safety: Biomechanical Engineering and Ergonomics

Transfer

Falls are common during wheelchair transfers [29, 30]. Since these titanium rigid frame wheelchairs are less stable in the rearward direction compared to the box style folding frame wheelchairs, more information about falling and tipping accidents while using these wheelchairs should be disclosed and investigated.

Manual wheelchair transfers are associated with increased risks for shoulder pain and injuries [31, 32]. During a transfer to or from a chair with a more forward axle position, the user must modify their transfer strategy in order to avoid falling or tipping. Therefore, further investigations are required to find alternative transfer strategies while using wheelchairs with a more forward axle position.

Transportation

Titanium wheelchairs are much lighter and compact. They are expected to demand less upper extremity strength and less space for storing them in vehicles. However, there is no survey or research to clarify the advantages of the rigid frame design for the users with private vehicles. The Society of Automotive Engineers J2249 and the ANSI/RESNA WC-19 wheelchair transportation standards recommend restraining the angles relative to the anchorage locations to

secure a occupant sitting the wheelchair in public transportation [33]. According to a research by van Roosmalen et al in 2002 [33], most wheelchair users experienced discomfort and difficulty when using wheelchair occupant restraint systems (WORSs) in paratransit or mass transit vehicles. Wheelchairs may tip or slide while a vehicle is turning or braking even though wheelchairs and occupants are secured [34]. The existing limitations of WORSs in public transportation may decrease the usage of WORSs and threaten the safety of wheelchair users in motor vehicles. The proper restraint position for ultralight rigid frame wheelchairs in public vehicles is unknown because the frame structure, stability, and occupants' position are different from those of the traditional box folding frame wheelchairs. The outcomes of future research on transportation for users of ultralight rigid frame wheelchairs should be disseminated to manufacturers and policy makers in order to improve the safety of wheelchair users in motor vehicles.

4.8.3 Users' Satisfaction

Based on the clinical guidelines [6], titanium ultralight rigid wheelchairs would be recommended for all everyday manual wheelchair users because of their light weight design. Nevertheless, there are problems when using this type of wheelchair according to the wheelchair reviews in USA TechGuide (<http://www.usatechguide.org/>). Footrests sliding down and feet sliding out of footrests are frequent problems. Cantilever frames are too flexible and make it difficult to roll over rough ground. These chairs are not as adjustable as some users' thought. Although the reviews from USA TechGuide are a good resource to know wheelchairs' quality and usage, they were not analyzed using reliable and valid research methods. More information

about users' satisfaction should be collected by systematic surveys or clinical research to gain better understanding of how these chairs are used in everyday life. Users' opinions are the most important reference to improve wheelchair design and refine clinical guidelines.

4.8.4 Development of Guidelines

This study reveals the stability, design, and engineering issues of the titanium ultralight rigid frame wheelchair. The information from the study and other related studies is valuable as the background for developing guidelines for manufactures to improve the quality of products, users' safety, and comprehensive clinical recommendations for clinicians.

For Manufacturers

According to the results of this study, manufacturers and designers may not use engineering principles to ensure that their designs are strong enough to meet the standards. The engineering flaws shown in this study are avoidable. A formal set of guidelines should be developed to remind manufacturers and designers that more rigorous engineering analysis and procedures should be performed.

For Users

Section 6.1 includes recommendations for the users of these wheelchairs. Information about choosing an appropriate wheelchair among all kinds of commercialized products and using a wheelchair properly are scattered and may be biased. Comprehensive and effective guidelines

for wheelchair selection and usage should be developed in order to improve wheelchair users' accessibility to research results and reliable professional recommendations.

For Clinicians

Recommendations for clinicians are provided in Section 6.2. More thorough guidelines for interpreting and applying the testing results of the ANSI/RESNA wheelchair standards are needed. The guidelines will not only benefit the clinicians in providing evidence-based recommendations for the users, but also increase the importance and visibility of the wheelchair standards.

5.0 CONCLUSIONS

This group of rigid frame Titanium wheelchairs has unique features that influence the trend of manual wheelchair design. Their highly adjustable rear wheel axles, ultra light-weight, and compact dimensions allow custom fit and adjustment for the end users to decrease physical stress on the user when propelling a wheelchair and increase ease of use. This study revealed important design issues that need to be addressed. Our results should remind manufactures and designers that each weld point, screw hole, and change in structure and frame design has its impact on the strength and durability of the wheelchair. Our results indicate that the manufacturers need to perform more thorough analyses before commercializing new products.

6.0 RECOMMENDATIONS AND CLINICAL APPLICATIONS

According to the results from this study, some recommendations could be provided to the users and clinicians to use this group of wheelchairs more safely and extend their durability.

6.1 FOR USERS OF RIGID FRAME TITANIUM WHEELCHAIRS

1. The user should be careful when hanging a backpack on the backrest or using an underneath carryon, as small change of the center of gravity will compromise the stability, and may cause the chair to tip backward.
2. When pushing the wheelchair on a hill, the user should lean into the slope. For example, when going downhill, the user should lean backward. The user should lean forward when going uphill.
3. When using a cantilever frame wheelchair with screws to fix the seat sling, the user should check the first and second screw holes regularly for possible fractures.
4. When using a box frame wheelchair with screws for fixing the seat sling and the backrest mounting piece, the user should check the screw holes regularly for possible fractures.
5. When using a wheelchair with fixed (welded) backrest angle, the user should check the welding area regularly for possible fractures around it. Also, you should avoid hanging heavy backpacks on the backrest as if add stress on the backrest cane.

6. If the footrest of the wheelchair is attached by a clamp or a set screw, the user should check and tighten the clamp or the set screw regularly to prevent the footrest from dropping unexpectedly.

6.2 FOR CLINICIANS

1. Before prescribing this group of wheelchairs to a novice user, the clinician should make sure that the user has acquired enough wheelchair skill to master the dynamics of stability of these wheelchairs.
2. When setting up the wheelchair for the user, the clinician should check the position of the rear wheel axle, and make sure that the screws are tightened to fix the axle in the position. A small change in the rear wheel axle position would influence the stability significantly. After adjusting the rear wheel axle, the clinician should make sure that the user is able to master the wheelchair on a slope.
3. If the user is not able to maintain a “wheelie” position while going through obstacles, bumps, or door thresholds, you should:
 - a. Educate the user about the durability of the wheelchair may be compromised as casters impact directly with obstacles; and
 - b. Recommend to use larger casters to decrease potential damage to the frame and increase ease with pushing through uneven terrain and negotiation of small obstacles. The user may use mini casters later when his wheelchair skills are good enough to pop a wheelie while negotiating obstacles.

4. Although the maximum weight capacity of this group of wheelchairs are around 113.6-136.4 kg (250-300 lbs), a user weighting close to the maximum limit may not be appropriate to use the titanium cantilever wheelchairs because the increased weight may decrease the durability of the wheelchairs.
5. The clinician should remind the user about the recommendations mentioned in the section 6.1.

7.0 BIBLIOGRAPHY

1. American National Standards Institute, Rehabilitation Engineering and Assistive Technology Society of North America, *American national standard for wheelchairs*, American National Standards Institute, Editor. 1998, American National Standards Institute.
2. Smith, C., M. McCreadie, and J. Unsworth, *Prescribing wheelchairs: the opinions of wheelchair users and their carers*. *Clinical Rehabilitation*, 1995. **9**(1): p. 74-80.
3. Trail, M., et al., *Wheelchair use by patients with amyotrophic lateral sclerosis: a survey of user characteristics and selection preferences*. *Archives of Physical Medicine & Rehabilitation*, 2001. **82**(1): p. 98-102.
4. Kittel, A., et al., *Factors influencing the decision to abandon manual wheelchairs for three individuals with a spinal cord injury*. *Disability & Rehabilitation*, 2002. **24**(1-3): p. 106-14.
5. Rogers, H., et al., *A comparison of functional mobility in standard vs. ultralight wheelchairs as measured by performance on a community obstacle course*. *Disability & Rehabilitation*, 2003. **25**(19): p. 1083-8.
6. *Prevention of Upper Limb Function Following Spinal Cord Injury: A Clinical Guideline for Health-Care Professionals*. 2005, Consortium for Spinal Cord Medicine. Paralyzed Veterans of America. p. 13-20.

7. Cooper, R.A., M.L. Boninger, and A. Rentschler, *Evaluation of selected ultralight manual wheelchairs using ANSI/RESNA standards*. Archives of Physical Medicine & Rehabilitation, 1999. **80**(4): p. 462-7.
8. Cooper, R.A., et al., *Performance of selected lightweight wheelchairs on ANSI/RESNA tests*. American National Standards Institute-Rehabilitation Engineering and Assistive Technology Society of North America. Archives of Physical Medicine & Rehabilitation, 1997. **78**(10): p. 1138-44.
9. *Part 3: Determination of effectiveness of brakeness*. 2003, International Standards Organization.
10. Winter, D.A., in *Biomechanics and Motor Control of Human*. 2005, John Wiley & Sons. Inc.: Hoboken, New Jersey.
11. Giangregorio, L. and N. McCartney, *Bone loss and muscle atrophy in spinal cord injury: epidemiology, fracture prediction, and rehabilitation strategies*. Journal of Spinal Cord Medicine, 2006. **29**(5): p. 489-500.
12. Cooper, R.A., *Wheelchair Standards and Testing*, in *Wheelchair selection and configuration*. 1998, Demos: New York p. 165-195.
13. Fitzgerald, S.G., et al., *Comparison of fatigue life for 3 types of manual wheelchairs*. Archives of Physical Medicine & Rehabilitation, 2001. **82**(10): p. 1484-8.
14. Pearlman, J.L., et al., *Evaluation of the safety and durability of low-cost nonprogrammable electric powered wheelchairs*. Archives of Physical Medicine & Rehabilitation, 2005. **86**(12): p. 2361-70.
15. Munro, B.H., *Selected Nonparametric Techniques*, in *Statistic Methods for Health Care Research*. 2005, Lippincott Williams & Wilkins. p. 109-136.

16. Di Marco, A., M. Russell, and M. Masters, *Standards for wheelchair prescription*. Australian Occupational Therapy Journal, 2003. **50**(1): p. 30-9.
17. Cooper, R.A., et al., *Life-cycle analysis of depot versus rehabilitation manual wheelchairs*. Journal of Rehabilitation Research & Development, 1996. **33**(1): p. 45-55.
18. Matthew J. Donachie, J., *Joint Technology and Practice*, in *Titanium: a technical guide*. 2000, ASM International: Material Park, OH. p. 65-78.
19. Technology, T.W.C.f.M.J. *Weldability of materials*. Titanium and titanium alloys. 1997 [cited 2007; Available from: http://www.twi.co.uk/j32k/protected/band_3/jk24.html].
20. eFunda. *Cantilever Beam Loading Options*. 2007 [cited 2007 June 25]; Available from: http://www.efunda.com/formulae/solid_mechanics/beams/casestudy_bc_cantilever.cfm.
21. Faterini, A., R.I. Stephens, and H.O. Fuchs, *Macro/Micro Aspects of Fatigue of Metals*, in *Metal Fatigue in Engineering* 2001, Wiley-IEEE. p. 33-41.
22. William, D. and J. Callister, *Materials Science and Engineering. An Introduction*. Third ed. 1994: John Wiley & Sons, Inc.
23. *Owner's Operator and Maintenance Manual*. TOP END Everyday and Sport Series Wheelchairs 2007 [cited 2007 October 22]; Available from: http://www.invacare.com/doc_files/1114851.pdf.
24. Boninger, M.L., et al., *Manual wheelchair pushrim biomechanics and axle position*. Archives of Physical Medicine & Rehabilitation, 2000. **81**(5): p. 608-13.
25. Gutierrez, D.D., et al., *Effect of fore-aft seat position on shoulder demands during wheelchair propulsion: part 2. An electromyographic analysis*. Journal of Spinal Cord Medicine, 2005. **28**(3): p. 222-9.

26. Gaal, R.P., et al., *Wheelchair rider injuries: causes and consequences for wheelchair design and selection.[see comment]*. Journal of Rehabilitation Research & Development, 1997. **34**(1): p. 58-71.
27. Kirby, R.L. and D.J. Dupuis, *Clinical measurement of the static rear stability of occupied wheelchairs*. Archives of Physical Medicine & Rehabilitation, 1999. **80**(2): p. 199-205.
28. Tomlinson, J.D., *Managing maneuverability and rear stability of adjustable manual wheelchairs: an update*. Physical Therapy, 2000. **80**(9): p. 904-11.
29. Kirby, R.L. and S.A. Ackroyd-Stolarz, *Wheelchair safety--adverse reports to the United States Food and Drug Administration*. American Journal of Physical Medicine and Rehabilitation 1995 Jul-Aug;74(4):308-12.
30. Ummat, S. and R.L. Kirby, *Nonfatal wheelchair-related accidents reported to the National Electronic Injury Surveillance System*. American Journal of Physical Medicine & Rehabilitation, 1994. **73**(3): p. 163-7.
31. Nawoczenski, D.A., et al., *Three-dimensional shoulder kinematics during a pressure relief technique and wheelchair transfer*. Archives of Physical Medicine & Rehabilitation, 2003. **84**(9): p. 1293-300.
32. Finley, M.A., K.J. McQuade, and M.M. Rodgers, *Scapular kinematics during transfers in manual wheelchair users with and without shoulder impingement*. Clinical Biomechanics, 2005. **20**(1): p. 32-40.
33. van Roosmalen, L., et al., *Preliminary evaluation of wheelchair occupant restraint system usage in motor vehicles*. Journal of Rehabilitation Research & Development, 2002. **39**(1): p. 83-93.

34. Wretstrand, A., J. Petzall, and A. Stahl, *Safety as perceived by wheelchair-seated passengers in special transportation services*. *Accident Analysis & Prevention*, 2004. **36**(1): p. 3-11.

8.0 SUPPLIERS

- a. Invacare, One Invacare Way, Elyria, OH 44036
- b. Quickie, Sunrise Medical, Longmont, Colorado 80503
- c. TiLite, Kennewick, Washington 99337